

P48=P49=P67=P68=P69=P70

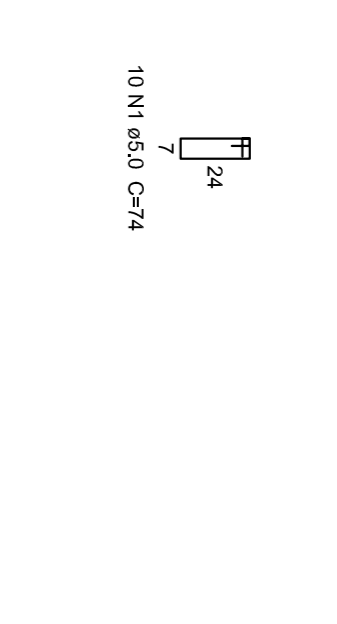

P42=P47=P90=P51

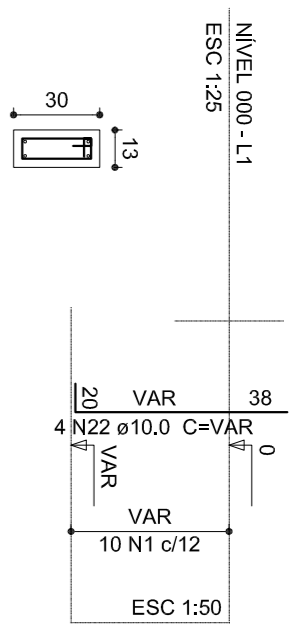
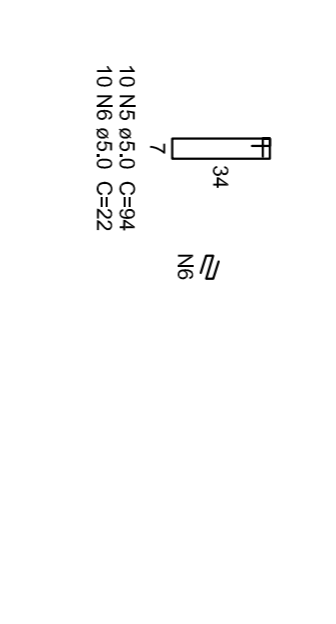
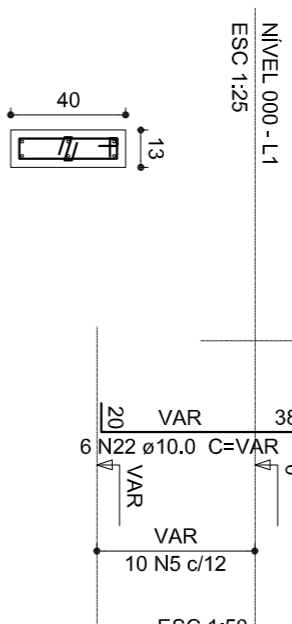

P83

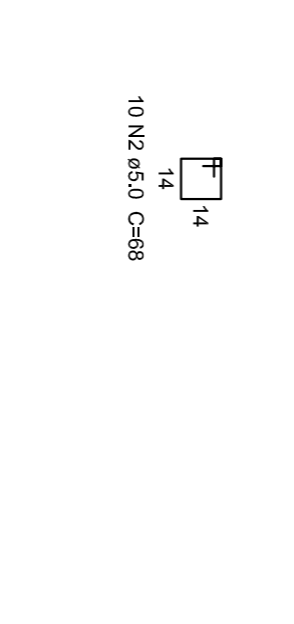
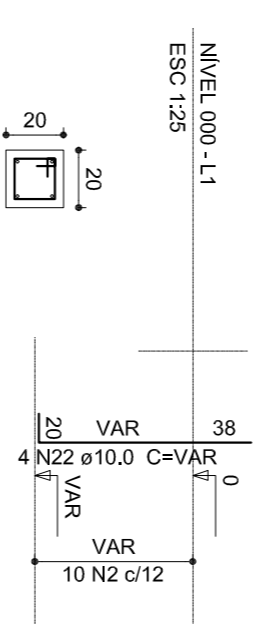

P14

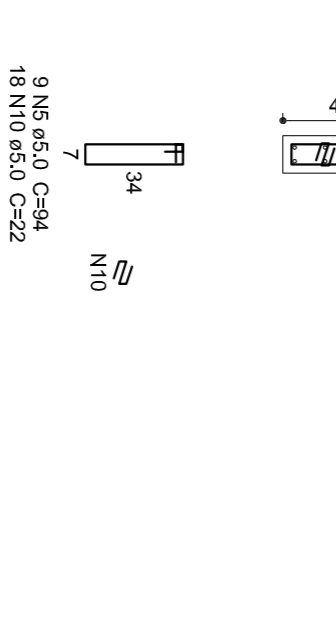
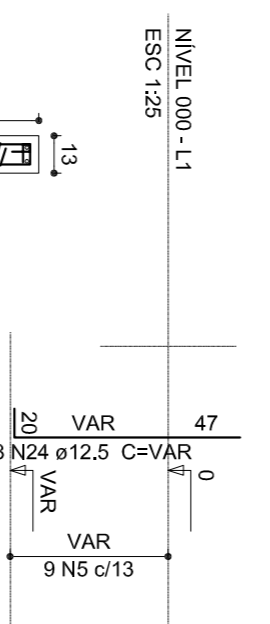

P75

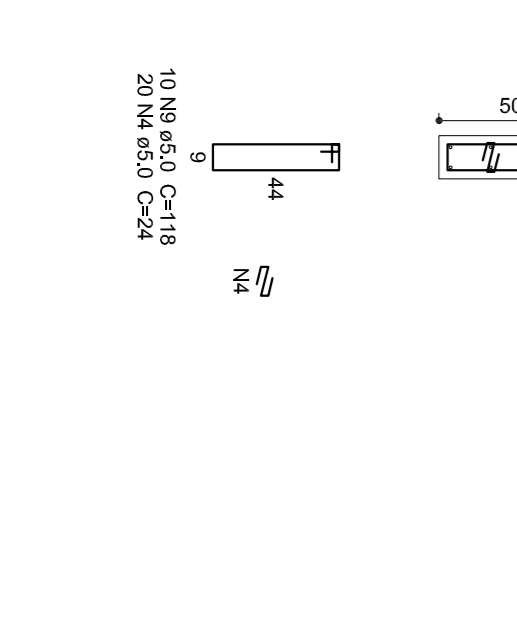
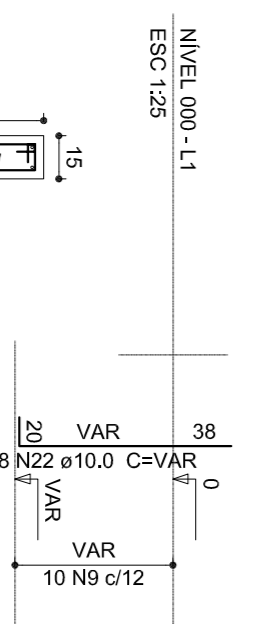

P12=P13=P20=P21=P30=P31=P40=P41=P55=P56

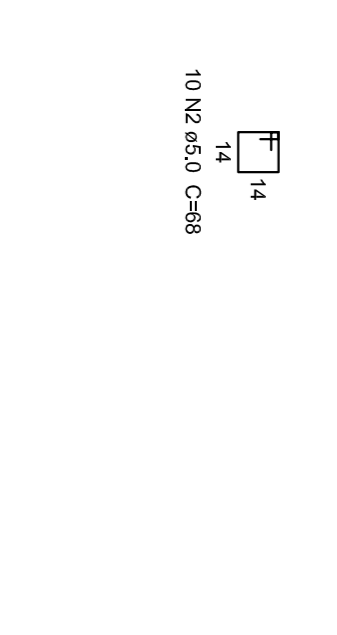
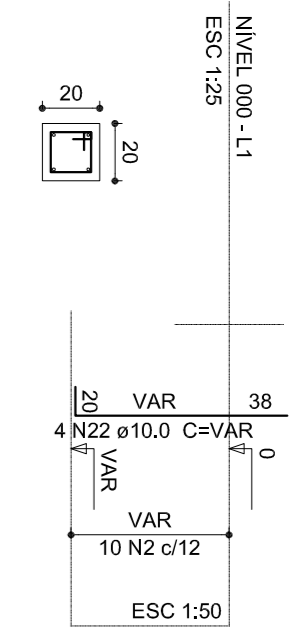

P25

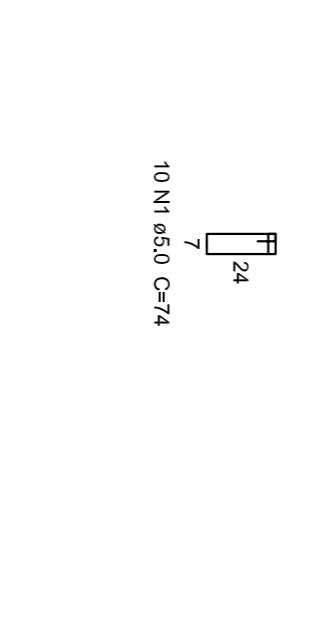
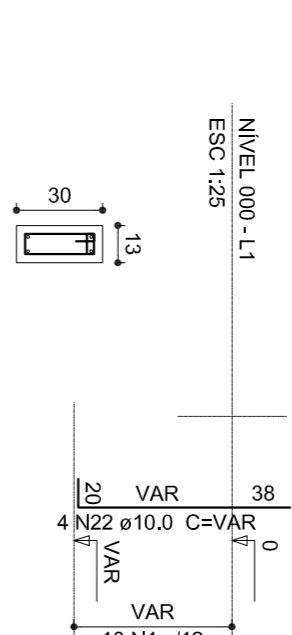

P4=P5=P8=P9=P16=P17=P24=P26=P27=P44=P46
P52=P57=P59=P66=P71=P74

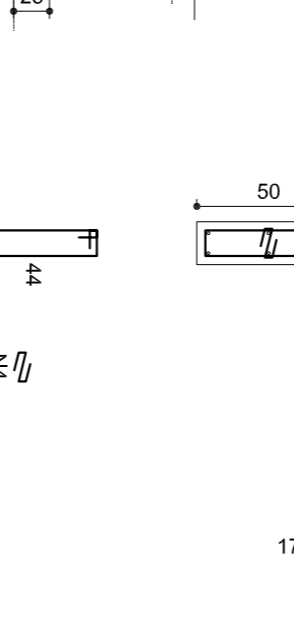
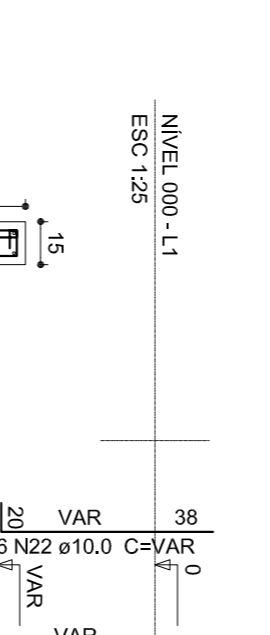

P39

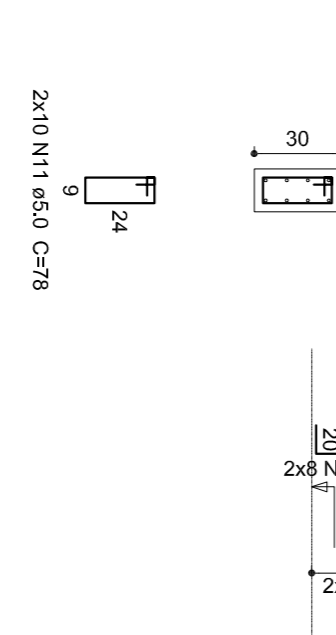
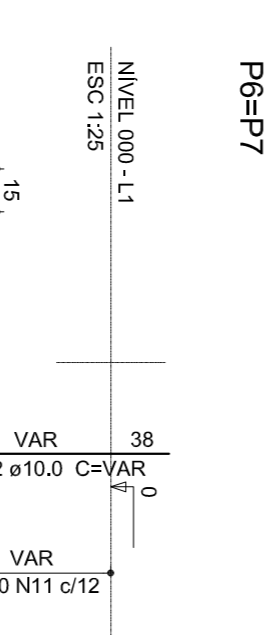

P11=P29=P61

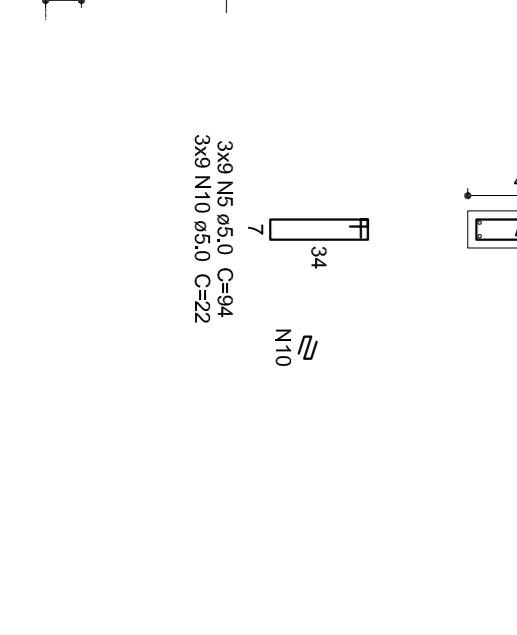
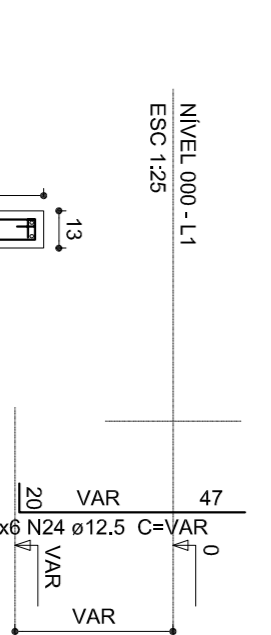

P43

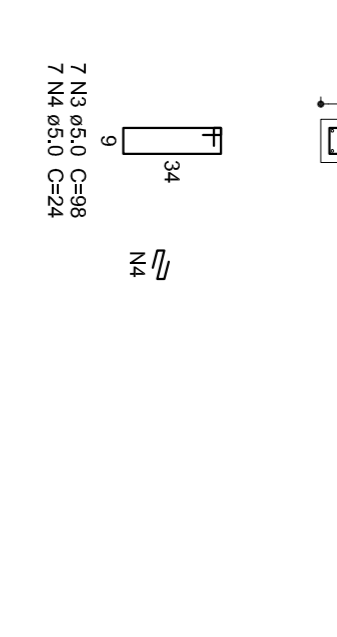
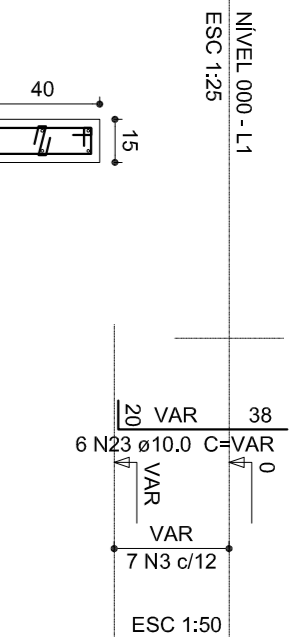

P35=P37

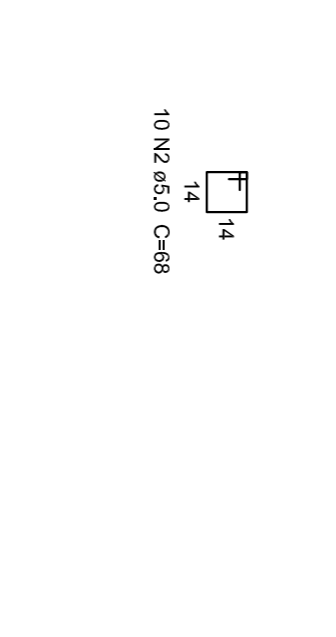
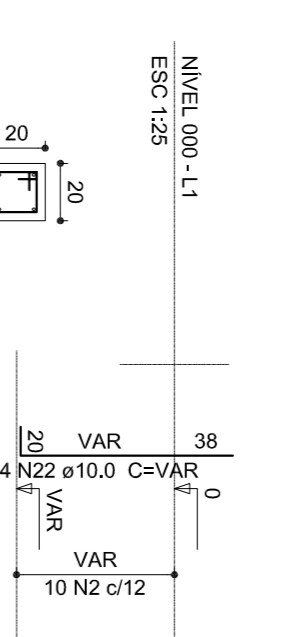

P64

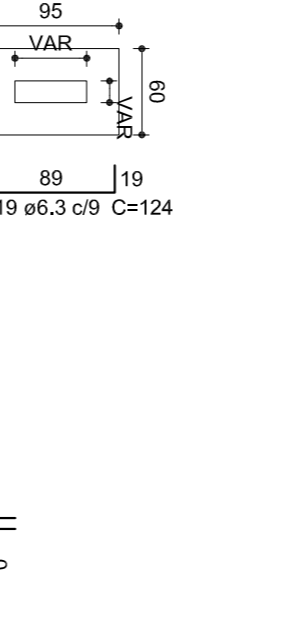
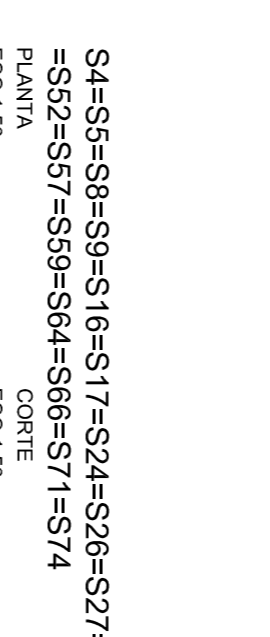

P72

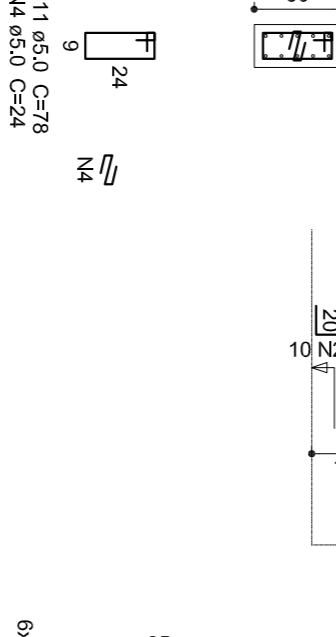
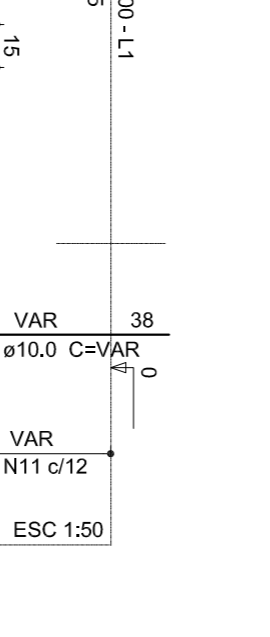

P15=P65

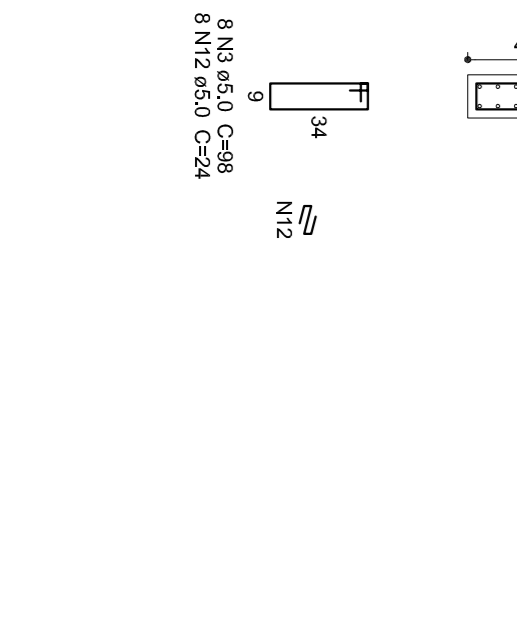
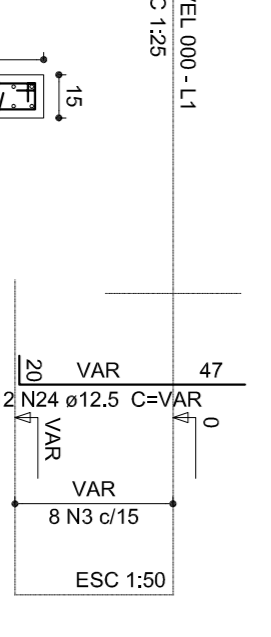

P45

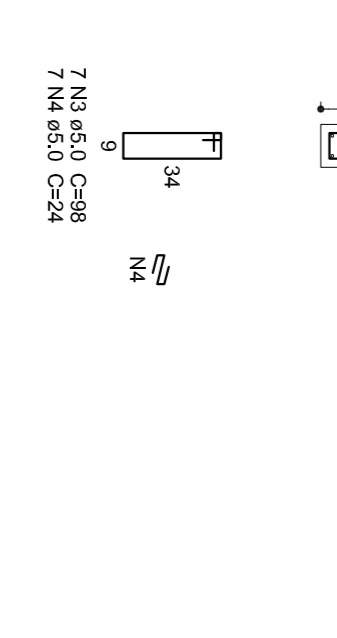
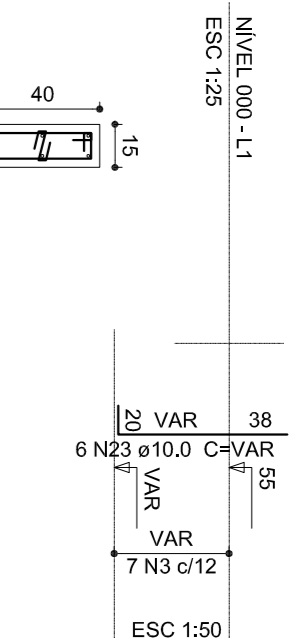

P62

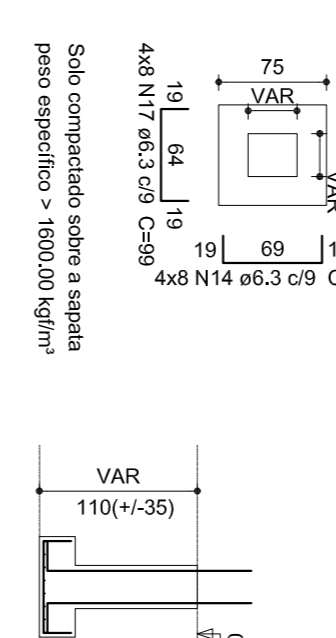
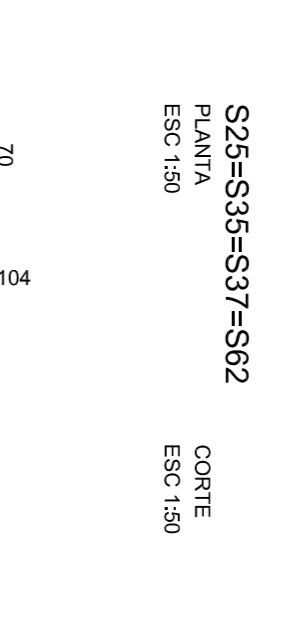

P66



P73

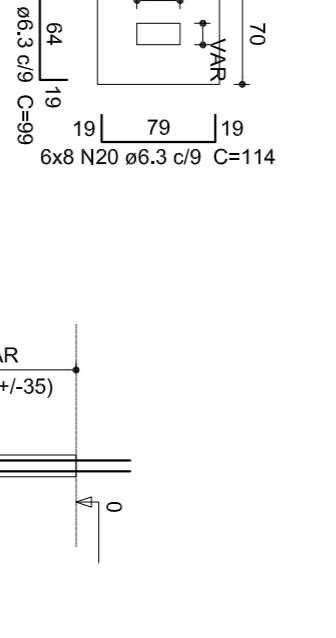
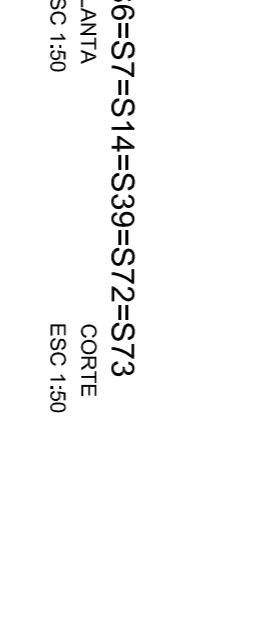

P58

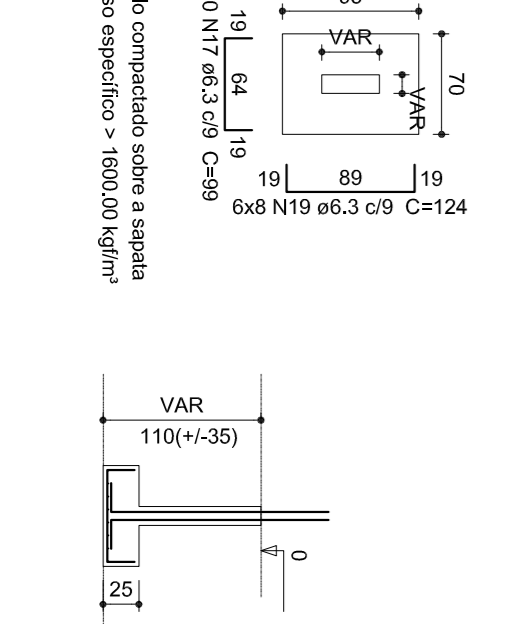
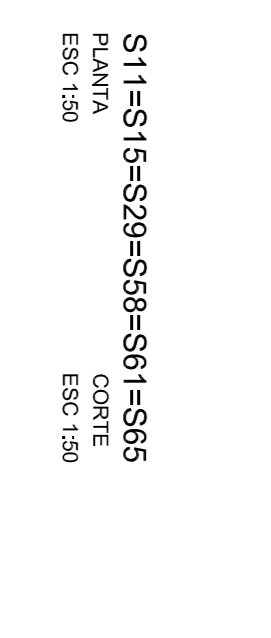

S48=S49=S67=S68=S69=S70

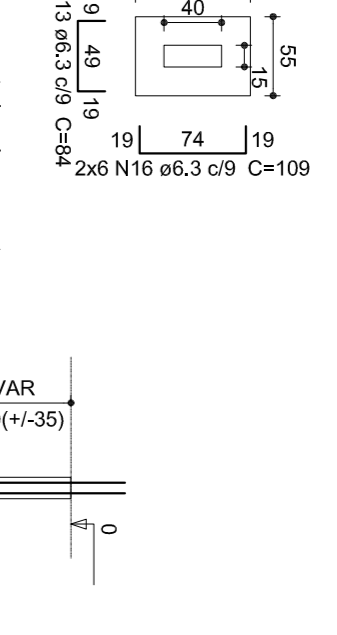

S47=S47=S50=S51



S63

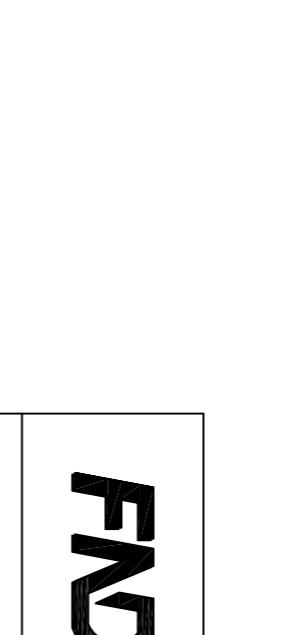

P39

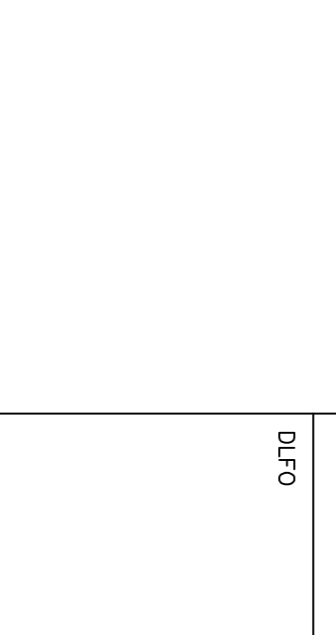
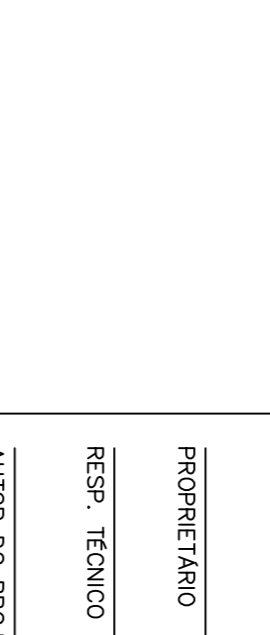

S75

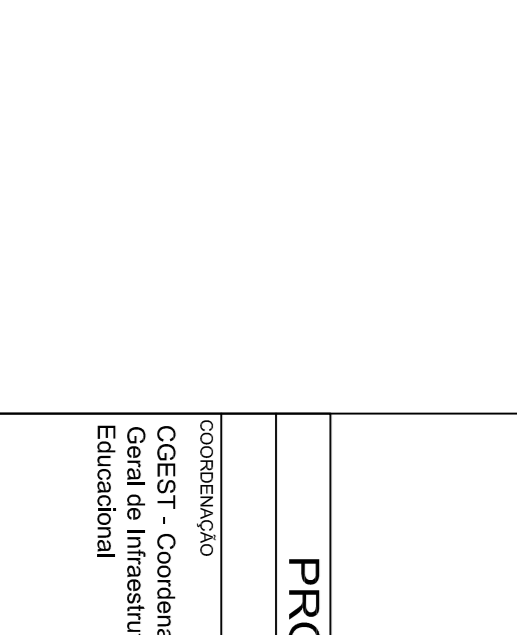
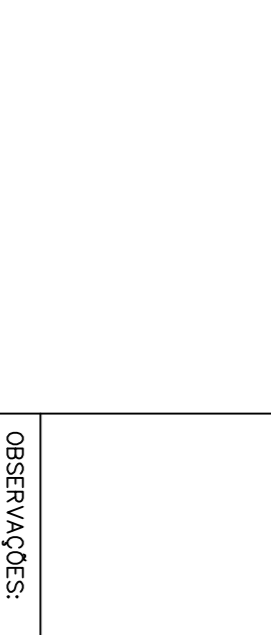

S12=S13=S20=S21=S30=S31=S40=S41=S55=S56



P35=P37

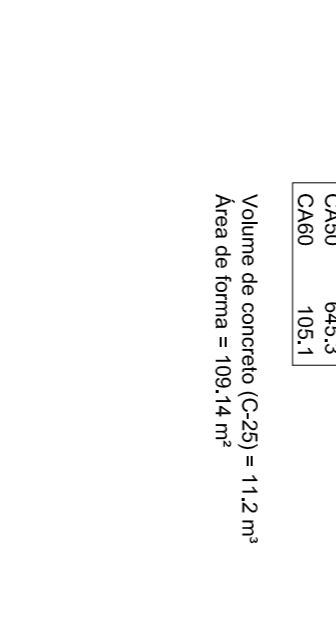
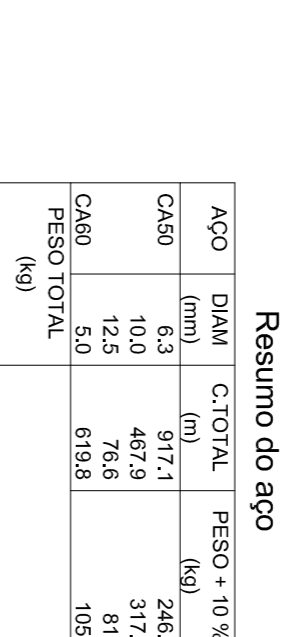

P64

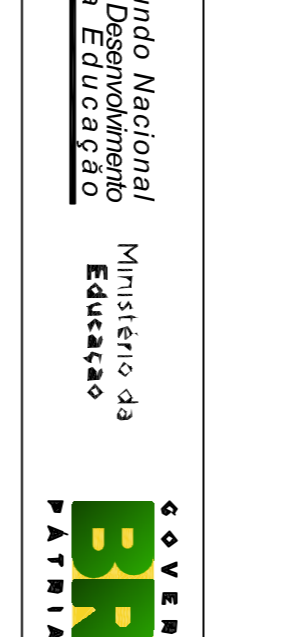

P72

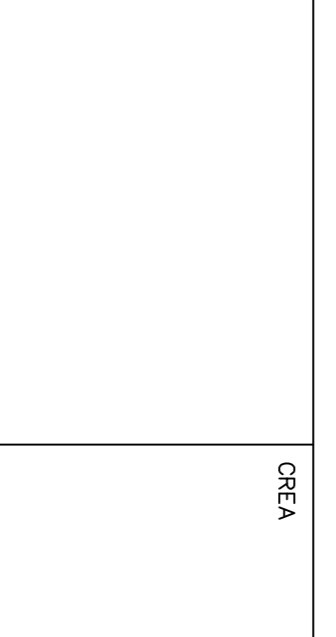
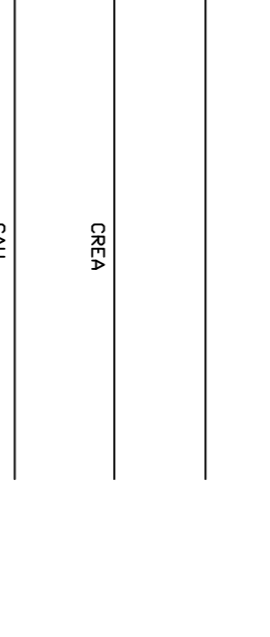

P15=P65

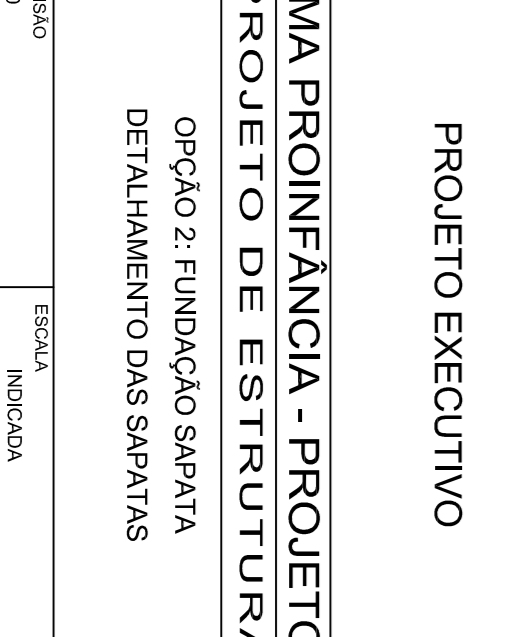
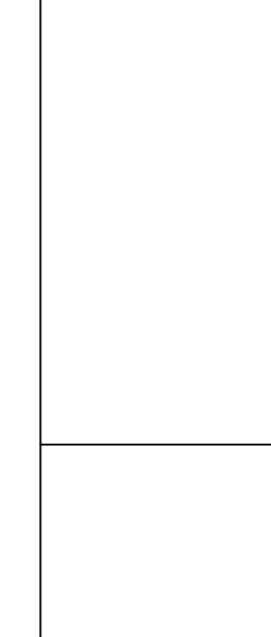

S43=S45



P62



S25=S35=S37=S62

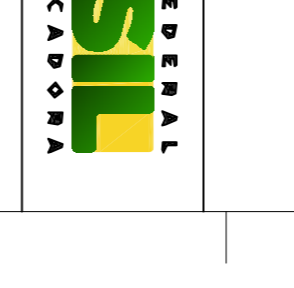

S6



S11=S15=S29=S58=S61=S65

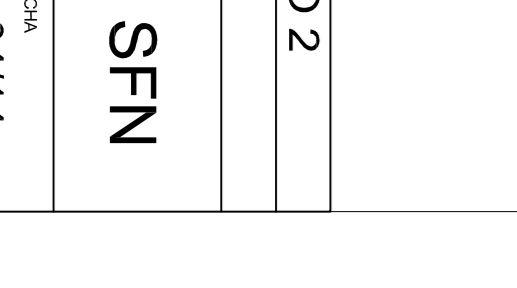
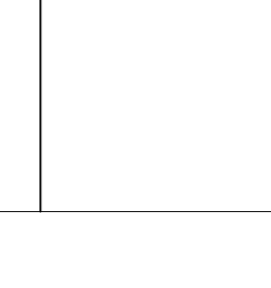

Resumo do aço

ACO	DIAM	C/TOTAL	PESO + 10 %
CA50	10,2	1174	246,9
CA50	12,5	487,1	311,1
CA60	5,0	76,6	81,1
PESO TOTAL	(kg)	618,8	106,1
CA50	448,3		
CA60	105,1		

Volume de concreto (C-20) = 11,2m³
Aço do forma = 103,4kg



PROJETO PADRÃO - FND E

PROPRIETÁRIO:	MUNICÍPIO - UF:
ENDEREÇO:	
PROPRIETÁRIO	CREA
RESP. TÉCNICO	CREA
AUTOR DO PROJETO	CAU
DIFEO	CREA
RA	

PROGRAMA PROINFÂNCIA - PROJETO TIPO 2

PROJETO DE ESTRUTURA

OPÇÃO 2: FUNDAÇÃO SAPATA	SFN	
DETALHAMENTO DAS SAPATAS		
FORMATO	INDICAÇÃO	PRONCIA
A1 (98x8x1)	JUNHO/2015	04/14